

BELT/CHAIN DRIVE GARAGE DOOR OPENERS PROGRAMMING, OPERATION, & MAINTENANCE MANUAL

Images are for illustration purposes only, Your model may have different covers, lenses, or accessories.

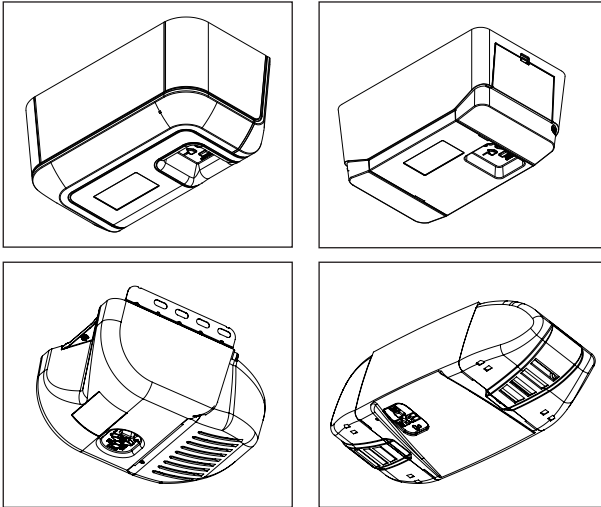

DO NOT use photocells from other manufacturers or openers with this opener.

INSTALLER: LEAVE THIS MANUAL WITH HOMEOWNER

HOMEOWNER: SAVE THIS MANUAL FOR FUTURE REFERENCE

! WARNING

To reduce the risk of injury to persons or damage to property, use this opener only with a sectional residential door.

! AVERTISSEMENT

Por reduire le risque de blessures ou de dommages materials, utilisez cet ouvre-porte uniquement pour une porte a section residential.



**DO NOT return product to store,
visit www.geniecompany.com
or call Customer Service at: 1-800-35-GENIE**

SERIAL NUMBER DECAL

IDCM SERIAL NUMBER DECAL

INDEX

1	Safety & General Information	
	Introduction	1
	Safety Notifications.....	2
	Important Installation Instructions.....	3
	Coin-Cell Battery Safety Warnings.....	4
2	Basic Wiring.....	5
3	Programming Information	
	Introduction to opener programming	6
	Setting the DOWN Limit	7
	Setting the UP Limit	8
	Setting the Force Control	9
	Contact Reverse Test	9
	Contact Reverse Adjustment	9
	Remote Control Programming	10
	Wireless Wall Console Install & Prog*	11
	Keypad Programming*.....	12
	Homelink & Car2U Programming*.....	13
	Aladdin Connect® Set up.....	14-15
4	Special Installation Information	
	Force Adjustment Guide.....	16
	Clearing Remote Memory	17
	Tube Rail Adjustments.....	17
	Location of Safe-T-Beam® Pairs.....	18
	Safe-T-Beam Troubleshooting	18
	Installing Battery Backup (BBU).....	19
5	Maintenance	
	Important Safety Instructions.....	20
	Regular Maintenance Schedule	21
	Door Inspection & Maintenance	21
	Carriage Adjustment (Release/Engagement	21
	Remote Battery Replacement.....	22
	Light Bulb Replacement	22
6	Troubleshooting & LED Signals.....	23-24
7	Replacement Parts & Assemblies.....	25-28
8	DASMA Safety Guidelines.....	29-30

** Abbreviated versions. See instructions that accompany the accessory or vehicle owners manual for full details and instructions.*

FCC Part 15.21 Statement:
Changes or modifications not expressly approved by the party responsible for compliance could void the user's authority to operate the equipment.

FCC / IC Statement:
This device complies with FCC Part 15 and Industry Canada licence-exempt RSS standard(s). Operation is subject to the following two conditions: (1) this device may not cause harmful interference, and (2) this device must accept any interference received, including interference that may cause undesired operation of the device.

Le présent appareil est conforme aux CNR d'Industrie Canada applicables aux appareils radio exempts de licence. L'exploitation est autorisée aux deux conditions suivantes : (1) l'appareil ne doit pas produire de brouillage, et (2) l'utilisateur de l'appareil doit accepter tout brouillage radioélectrique subi, même si le brouillage est susceptible d'en compromettre le fonctionnement.



The Genie Company
One Door Drive
Mt. Hope, OH 44660, USA
1-800-35-GENIE (354-3643)
www.geniecompany.com

Patent listing at www.geniecompany.com/patents

SAVE THESE INSTRUCTIONS

READ AND FOLLOW ALL INSTRUCTIONS

1 INTRODUCTION

Thank you for purchasing a Genie® brand garage door opener. Genie® is the leader in garage door opener technology.

Please note that this manual covers several different models of Genie® brand garage door openers. Illustrations contained in this manual may not reflect the exact model purchased. Skip steps or pages that do not apply to your specific model. Programming and installation of the opener and accessories are identical even though they may appear differently.

All external accessories shown in this manual are available for purchase separately from your local Genie® retailer.

Read and understand all **SAFETY WARNINGS and **CAUTIONS** contained in this manual before proceeding.**



DO NOT RETURN PRODUCT TO STORE

If you require assistance or have any questions, a knowledgeable Genie Service Technician is just a phone call away at:

1-800-35-GENIE (1-800-354-3643)

Or visit our website at:

www.geniecompany.com

Before setting up your new garage door opener, please note the model plate on the opener and serial number(s) located on the front of this manual. This information will be necessary should you seek technical support via our website, customer support department or local servicing Genie dealer.

Spanish language manuals available at:

Idioma alternativo manuales disponibles en:



www.geniecompany.com

©2024 GMI Holdings, Inc d/b/a The Genie Company, the Genie logo, Intellicode, Safe-T-Reverse, SmartSet, Sure-Lock, Door Detect, and Safe-T-Beam, Aladdin Connect, iDCM, are trademarks of The Genie Company. All other trademarks are property of their rightful owners. Consistent with our policy of continuing product improvements, we reserve the right to change product specifications without prior notice or obligations. HomeLink is a registered trademark of Gentex Corporation. Car2U is a registered trademark of Lear Corporation.

SAFETY NOTIFICATIONS & INSTRUCTIONS

OVERVIEW OF POTENTIAL HAZARDS READ THIS SAFETY INFORMATION

Garage doors are large, heavy objects that move with the help of springs under high tension and electric motors. Since moving objects, springs under tension, and electric motors can cause injuries, your safety and the safety of others depend on you reading the information in this manual. If you have questions or do not understand the information presented, call your nearest trained door system technician or visit our website at www.geniecompany.com.

CONVENTIONS USED IN THESE INSTRUCTIONS

The following safety alert symbol and signal words are used throughout this manual to call attention to and identify different levels of hazards and special instructions.

This is the safety alert symbol. This symbol alerts you to potential hazards that can kill or hurt you and others. All safety messages will follow the safety alert symbol and the word **"DANGER"**, **"WARNING"**, or **"CAUTION"**.









- **DANGER** indicates an imminently hazardous situation which, if NOT avoided, will result in death or serious injury.
- **WARNING** indicates a potentially hazardous situation which, if NOT avoided, could result in death or serious injury.
- **CAUTION** indicates a potentially hazardous situation which, if NOT avoided, may result in injury or property damage.
- The word **NOTE** is used to indicate important steps to be followed or important considerations.

Tous les messages concernant la sécurité seront indiqués après un symbole d'alerte de la sécurité et l'une des mentions suivantes **"DANGER"**, **"AVERTISSEMENT"** ou **"MISE EN GARDE"**.









- **DANGER** signale une situation dangereuse imminente qui, si elle n'est pas évitée, risque d'entraîner des blessures graves, voire mortelles.
- **AVERTISSEMENT** signale une situation potentiellement dangereuse qui, si elle n'est pas évitée, risque d'entraîner la mort ou des blessures graves.
- **MISE EN GARDE** signale une situation potentiellement dangereuse qui, si elle n'est pas évitée, risque d'entraîner des blessures ou des dommages matériels.
- Le terme **REMARQUE** est utilisé pour signaler les étapes importantes à suivre ou d'importants éléments à prendre en considération.

IMPORTANT SAFETY INSTRUCTIONS

POTENTIAL HAZARD	EFFECT	PREVENTION
MOVING DOOR 	 WARNING Could result in Serious Injury or Death	DO NOT operate unless the doorway is in sight and free of obstructions. Keep people clear of opening while door is moving. DO NOT allow children to play with the door opener. DO NOT change opener control to momentary contact unless an external reversing means is installed. DO NOT operate a door that jams or one that has a broken spring.
ELECTRICAL SHOCK 	 WARNING Could cause Serious Injury or Death	Turn off electrical power before removing opener cover. When replacing the cover, make sure wires are not pinched or near moving parts. Opener must be electrically grounded.
HIGH SPRING TENSION 	 WARNING Could cause Serious Injury or Death	DO NOT try to remove, repair or adjust springs or anything to which door spring parts are fastened such as wood block, steel brackets, cables or any other structure or like item. Repairs and adjustments must be made by a trained service representative using proper tools and instructions.

IMPORTANTES CONSIGNES DE SÉCURITÉ

DANGER POTENTIEL	EFFET	PRÉVENTION
PORTE EN MOUVEMENT 	 AVERTISSEMENT Pourrait entraîner des blessures graves voire la mort	Utiliser uniquement si la porte est en vue et libre de tout obstacle. Ne laisser personne se tenir dans l'ouverture de la porte pendant qu'elle est en mouvement. NE PAS permettre aux enfants de jouer avec l'opérateur de la porte. NE PAS modifier la commande de l'opérateur à contact momentané à moins qu'un moyen d'inversion externe soit installé. NE PAS faire fonctionner une porte qui bloque ou dont le ressort est cassé.
CHOC ÉLECTRIQUE 	 AVERTISSEMENT Pourrait entraîner des blessures graves voire la mort	Couper le courant avant d'enlever le couvercle de l'opérateur. Lorsque le couvercle doit être remplacé, s'assurer que les fils ne sont ni coincés ni près des pièces mobiles. L'opérateur doit être correctement mis à la terre.
TENSION ÉLEVÉE RESSORT 	 AVERTISSEMENT Pourrait entraîner des blessures graves voire la mort	NE PAS essayer d'enlever, réparer ni ajuster les ressorts ou toute autre pièce à laquelle le ressort de la porte est attaché, y compris blocs de bois, supports en acier, câbles ou autres articles semblables. Les réparations et les réglages doivent être effectués par technicien qualifié qui se sert d'outils appropriés et qui respecte les instructions.

IMPORTANT INSTALLATION INSTRUCTIONS



WARNING

TO REDUCE THE RISK OF SEVERE INJURY OR DEATH

READ AND FOLLOW ALL SAFETY, INSTALLATION AND OPERATION INSTRUCTIONS. If you have any questions or do not understand an instruction, call The Genie Company.

- **DO NOT** install opener on an improperly balanced door. An improperly balanced door could cause severe injury. Repairs and adjustments to cables, spring assembly and other hardware must be made by a trained service person using proper tools and instructions.
- Remove all ropes, and disable all locks connected to the door before installing opener.
- Where possible, install the door opener 7 feet or more above the floor. For products having an emergency release, mount the emergency release within reach, but at least 6 feet above the floor and avoiding contact with vehicles to avoid accidental release. **DO NOT** use emergency release cord to pull door.
- **DO NOT** connect the opener to the source of power until instructed to do so.
- Locate the wall control button: A) Within sight of door. B) At a minimum height of 5 feet, so small children cannot reach it. C) Away from all moving parts of the door.
- Install the entrapment WARNING label next to the wall button or console, in a prominent location. Install the emergency release handle on the emergency release cord.
- The opener must reverse when the door contacts a 1-1/2 inch high object on the floor at the center of the doorway. This is about the size of a 2" x 4" board laid flat.

IMPORTANTES INSTRUCTIONS D'INSTALLATION



AVERTISSEMENT

POUR RÉDUIRE LES RISQUES DE BLESSURES GRAVES VOIRE MORTELLES

LIRE ET SUIVRE ATTENTIVEMENT TOUTES LES INSTRUCTIONS D'INSTALLATION ET DE FONCTIONNEMENT AINSI QUE TOUTES LES CONSIGNES DE SÉCURITÉ. Si vous avez des questions ou si vous ne comprenez pas une instruction, veuillez contacter directement The Genie Company.

- **NE PAS** installer l'opérateur sur une porte mal équilibrée. Celle-ci pourrait entraîner de graves blessures. Les réparations et les réglages des câbles, ensembles de ressort ou tout autre article de quincaillerie doivent être effectués par un professionnel qui se sert d'outils appropriés et qui respecte les instructions.
- Enlever toutes les cordes et désactiver toutes les verrous de la porte avant l'installer l'opérateur.
- Dans la mesure du possible, installer l'ouvre-porte à 2,1 m ou plus au-dessus du sol. Pour les produits dotés d'un cordon de déclenchement d'urgence, installer le déclenchement d'urgence mais au moins à 1,8 m au-dessus du sol en évitant tout contact avec les véhicules pour éviter qu'ils ne soient déclenchés accidentellement. **NE PAS** utiliser d'urgence cordon de libération pour ouvrir ou fermer la porte.
- **NE PAS** connecter l'opérateur à la source d'alimentation tant que l'instruction n'est pas donnée.
- Repérer la console murale: A) En vue de la porte. B) À une hauteur minimale de 1,5 m afin que les jeunes enfants ne puissent pas l'atteindre. C) Loin de toutes pièces mobiles de la porte du garage.
- Placer l'étiquette d'AVERTISSEMENT en cas de coinçage à proximité du bouton mural ou de la console de manière à ce qu'elle soit bien en évidence. Installer la poignée du cordon de déclenchement d'urgence.
- L'opérateur doit s'inverser lorsque la porte entre en contact avec un objet d'une hauteur de 3,8 cm placé sur le sol, au centre de l'ouverture de la porte. Ceci équivaut environ à une planche de 5 x 10 cm posée à plat sur le sol.



WARNING

Opener is equipped with grounded electrical plug for your protection, and **only fits grounded electrical outlets. DO NOT** alter plug in any way! **If your have no grounded outlets, have one installed by a licensed electrician.** Opener must be properly grounded to prevent personal injury and equipment damage. **NEVER USE AN EXTENSION CORD!** Check local building codes for any requirement that you must have a permanent hard-wired connection. Permanent hard-wired connections must be performed by a licensed electrician using proper tools and instructions.



AVERTISSEMENT

L'opérateur, qui est équipé d'une prise électrique mise à la terre pour votre protection **est compatible uniquement avec des prises électriques mises à la terre. NE PAS** modifier la fiche d'une quelconque manière. Si vous n'avez pas de prises mises à la terre, faites-en installer par un électricien agréé. L'opérateur doit être correctement mis à la terre pour éviter les blessures corporelles et des dommages matériels. **NE JAMAIS UTILISER DE RALLONGE!** Vérifiez les codes locaux des bâtiments pour connexions câblées permanente. Les connexions câblées permanentes doivent être effectuées par un électricien agréé qui se servira d'outils appropriés et respectera les consignes.

COIN-CELL BATTERY SAFETY WARNINGS



WARNING

- **INGESTION HAZARD:** this product contains a button cell or coin battery.
- **DEATH** or serious injury can occur if ingested.
- A swallowed button cell or coin battery can cause Internal Chemical Burns in as little as 2 hours.
- **KEEP** new and used batteries **OUT OF REACH OF CHILDREN**
- Seek immediate medical attention if a battery is suspected to be swallowed or inserted inside any part of the body.



- Remove and immediately recycle or dispose of used batteries according to local regulations and keep away from children.
DO NOT dispose of batteries in household trash or incinerate.
- Even used batteries may cause severe injury or death.
- Call a local poison control center for treatment information.
- Replace only with Type CR2032 3V batteries.
- Non-rechargeable batteries are not to be recharged.
- **DO NOT** force discharge, recharge, disassemble, heat above (manufacturer's specified temperature rating) or incinerate. Doing so may result in injury due to venting, leakage or explosion resulting in chemical burns.
- Ensure the batteries are installed correctly according to polarity (+ and -).
- **DO NOT** mix old and new batteries, different brands or types of batteries, such as alkaline, carbon-zinc, or rechargeable batteries.
- Remove and immediately recycle or dispose of batteries from equipment not used for an extended period of time according to local regulations.
- Always completely secure the battery compartment. If the battery compartment does not close securely, stop using the product, remove the batteries, and keep them away from children.



AVERTISSEMENT

- **DANGER D'INGESTION :** Ce produit contient une pile bouton ou une pile bouton.
- La **MORT** ou des blessures graves peuvent survenir en cas d'ingestion.
- Une pile bouton ou une pile bouton avalée peut provoquer des dommages chimiques internes brûle en seulement 2 heures.
- **GARDER** les piles neuves et usagées **HORS DE LA PORTÉE DES ENFANTS**
- Consultez immédiatement un médecin si vous soupçonnez qu'une batterie est avalé ou inséré dans n'importe quelle partie du corps.



- Retirez et recyclez ou jetez immédiatement les piles usagées conformément aux réglementations locales et gardez-les hors de portée des enfants. Ne jetez **PAS** les piles avec les ordures ménagères ou ne les incinerez pas.
- Même les piles usagées peuvent provoquer des blessures graves, voire la mort.
- Appelez un centre antipoison local pour obtenir des informations sur le traitement.
- Remplacez uniquement par des piles de type CR2032 3 V.
- Les piles non rechargeables ne doivent pas être rechargées.
- Ne forcez pas la décharge, la recharge, le démontage, la chaleur au-dessus de la température nominale spécifiée par le fabricant et l'incinération. Cela pourrait entraîner des blessures dues à une ventilation, une fuite ou une explosion entraînant des brûlures chimiques.
- Assurez-vous que les piles sont installées correctement selon la polarité (+ et -).
- Ne mélangez pas des piles anciennes et neuves, des marques ou des types de piles différents, tels que des piles alcalines, carbone-zinc ou rechargeables.
- Retirez et recyclez ou jetez immédiatement les batteries des équipements non utilisés pendant une période prolongée, conformément aux réglementations locales.
- Sécurisez toujours complètement le compartiment à piles. Si le compartiment des piles ne se ferme pas correctement, arrêtez d'utiliser le produit, retirez les piles et gardez-les hors de portée des enfants.

2 BASIC WIRING

⚠ CAUTION

When using insulated staples, make only snug enough to hold electrical wire in place. Staples too tight can cause damage to wire and cause Safe-T-Beam® System to malfunction.

⚠ CAUTION

Lors de l'utilisation des agrafes isolées, serrez suffisamment pour tenir le fil en place mais sans plus. Si vous serrez trop, vous risquez d'endommager les fils et de provoquer le dysfonctionnement du système Safe-T-Beam®.

⚠ WARNING

Use of any other wall control can cause unexpected operation of the door and loss of lighting feature. Locate wall console within sight of door and far enough from door to prevent contacting it while operating the console. Control must be at least 5 feet above floor to prevent small children from operating it.

⚠ AVERTISSEMENT

L'utilisation d'une autre commande murale pourrait produire des résultats inattendus de la porte ainsi que le dysfonctionnement de l'éclairage. Localisez la console murale en vue de la porte et suffisamment loin de la porte pour éviter tout contact pendant l'utilisation de la console. La commande doit être à une hauteur minimale de 1,5 m au-dessus du sol afin que les jeunes enfants ne puissent pas l'atteindre.

Use the following as a basic wiring guide. If you require professional assistance with the physical assembly or installation of a complete opener, please contact your local Genie dealer or call us at 1-800-35-GENIE for guidance.

Safe-T-Beam Sensors

For each sensor, remove ¼" insulation from the white and striped wires and secure the wire under each screw terminal. See the graphic at right for connection to powerhead.

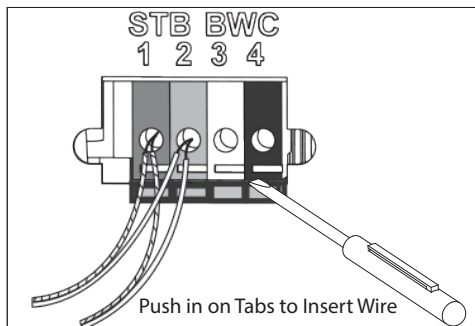
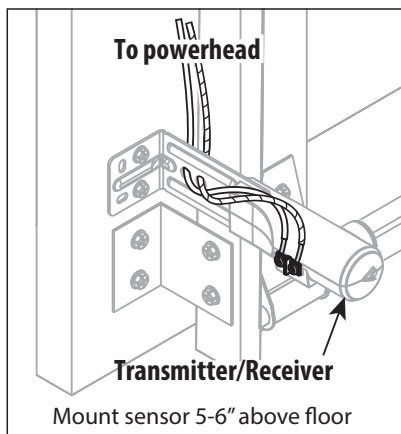

SAFE-T-BEAM WIRES:
Striped Wires to Terminal 1
White Wires to Terminal 2

WALL CONSOLE WIRES:
White Wire to Terminal 3
Striped Wire to Terminal 4

Wall Console

Remove ¼" insulation from the white and striped wires and secure white to the "W" (-) terminal and striped to the "B" or "B/W" (+) terminal as shown. Post an ENTRAPMENT WARNING LABEL (varies by model) next to the console. See above for connection to powerhead. (If you have a wireless console, review its section of the manual). One wired lighted wall console per opener, and additional wired, non-lighted push buttons can be used.

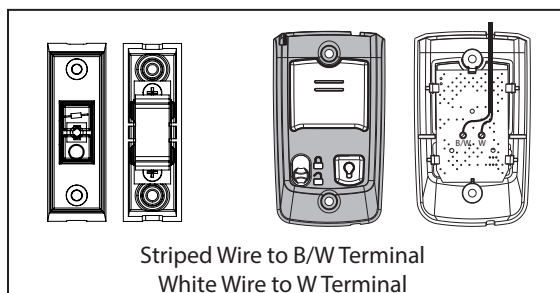

NOTE: Before programming the opener, check to make sure there are no objects in the garage door opening. DO NOT allow persons to enter the area of the door while programming and operating.

Please note that this manual covers several different models of Genie® brand garage door openers. Illustrations contained in this manual may not reflect the exact model purchased. Skip steps or pages that do not apply to your specific model. Programming and installation of the opener and accessories are identical even though they may appear differently.

The following steps list the order of programming the opener's functional settings and install any accessories that were included with the opener or purchased separately. These steps should be performed in order.

1. Down travel limit
2. Up travel limit
3. Force control
4. Contact reverse test and adjustment
5. Remote control programming
 - Remote control(s) included with this opener are programmed at the factory.
6. Accessory programming :
 - Install and program wireless wall console (if equipped)
 - Program wireless keypad (if applicable)
 - Program built in vehicle remote (if applicable)
 - Program the integrated Aladdin Connect if equipped
7. Install battery backup (if equipped)

Term Definitions:

Travel Limits Programmable setting to adjust how far door travels up or down.

Force Control refers to how much power is needed to move (open/close) a particular door and will initially be set with the first full cycle of the door.

Remote & Accessory Programming synchronizes remote devices with the powerhead. (Remote Controls, Aladdin Connect®, Wireless Keypad, Vehicle Remote Systems)

Programming Button Layouts (Vary by Models)

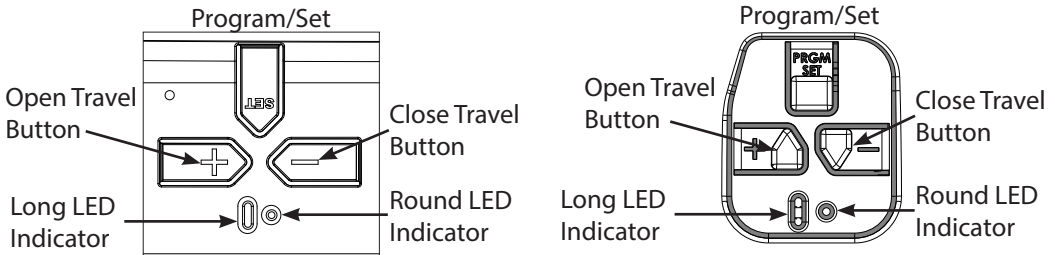

NOTE: Each programming step has a 30 second time limit for completion after the function is initiated. After 30 seconds, both LED's will illuminate RED indicating time has expired and the step must be restarted. Restart the step as many times as necessary to complete the programming.

SETTING DOWN TRAVEL LIMIT

⚠ WARNING

- Make sure doorway is in full view and clear of obstacles and people to avoid injury or property damage.
- DO NOT operate this unit from the wall control before LIMITS are set. Severe damage to the opener could occur.
- The carriage MUST be engaged to turnbuckle BEFORE setting limits. See installation poster or call Customer Service at 1-800-35-GENIE or visit www.geniecompany.com.
- DO NOT set limits with Battery Backup attached. AC power MUST be connected to the opener while setting limits for proper operation.

⚠ AVERTISSEMENT

- S'assurer que le passage de la porte est visible et dégagé, à savoir sans obstacles ni personne afin d'éviter toute blessure potentielle ou dommage matériel.
- NE PAS utiliser cette unité avec la console murale avant d'avoir réglé les LIMITES. L'ouvre-porte pourrait subir de sérieux dommages.
- La tendeur DOIT être engagée dans le chariot AVANT de régler les limites. Voir le poster d'installation (si fourni) ou appelez le service clientèle au 1-800-35-GENIE ou visitez le site www.geniecompany.com.
- NE PAS fixer de limites en mode batterie de secours. L'alimentation CA DOIT être branchée sur l'ouvre-porte, pendant le réglage des limites, pour assurer un bon fonctionnement.

⚠ NOTE: Carriage should be locked to opener. Door should rest somewhere between full open and closed. Do not start with door fully open or closed.

Programming DOWN Limit:

1. Press and hold the DOWN arrow button.
 - Long LED will light BLUE.
2. Release DOWN arrow button.
 - Long LED will flash BLUE.
3. Press and hold the DOWN arrow button until door is fully closed.
 - Use the UP arrow button if door closes too far. Use both UP and DOWN buttons to adjust close travel as necessary.

Door should rest on the floor until the weather strip is compressed enough to seal along the width of the door. Damaged doors or uneven floors may not seal properly. Repair these conditions to achieve a proper seal. DO NOT compress seal so much that the door will bend or buckle.

4. Press and release the PRGM/SET button
 - Both LEDs will flash BLUE then go out.

The DOWN limit is now programmed.

TO ENGAGE DOOR TO CARRIAGE:
Lift door by hand until carriage engages the bullet on the chain/belt systems.

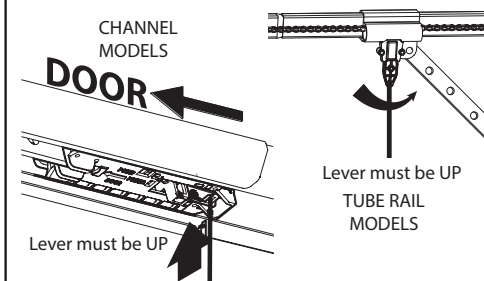

1-2. Enter Programming Mode

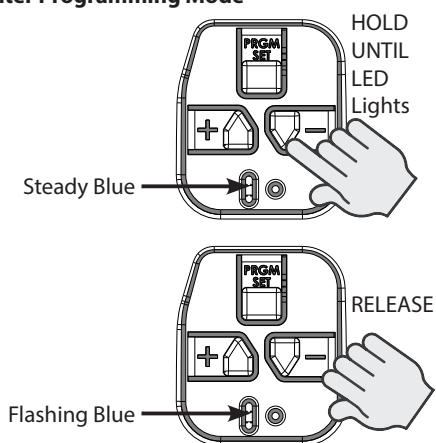

3. Adjust Door Position

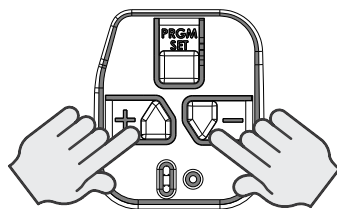

4. Lock Programming

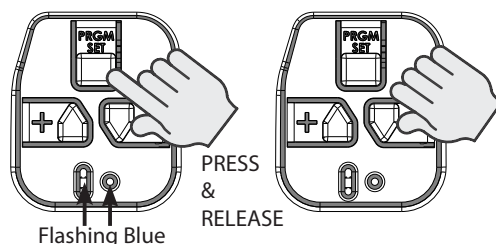

SETTING UP TRAVEL LIMIT

Programming UP Limit:

1. Press and hold the UP arrow button.
 - Long LED will light BLUE.
2. Release UP arrow button.
 - Round LED will flash BLUE.
3. Press and hold the UP arrow button until door is fully open.
 - Use the DOWN arrow button if door opens too far. Use both UP and DOWN buttons to adjust open travel as necessary.

Door should fully open so that door seal is even with door header. Do Not adjust so much that the door will bend or buckle or stretch door spring cables backward.

4. Press and release the PRGM/SET button.
 - Both LEDs will flash BLUE then go out.

The UP limit is now programmed.

1-2. Enter Programming Mode

HOLD
UNTIL
LED
Lights

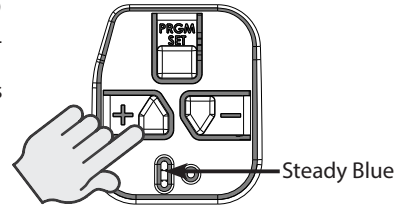

RELEASE

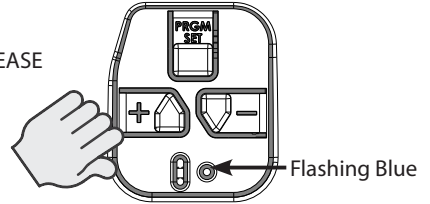

3. Adjust Door Position

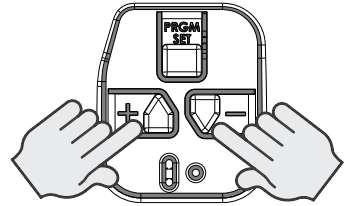

4. Lock Programming

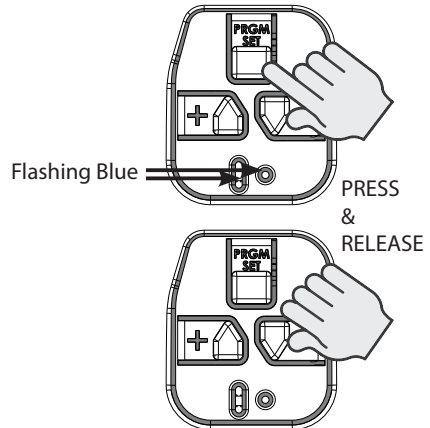

SETTING FORCE AND CONTACT REVERSE

Force Control

The force controls are automatically set when the wall control is used for the first time with garage door opener. The door **MUST** complete one full cycle, from full open to full close and then, full close to full open, before the settings are automatically recorded.

WARNING

TO AVOID INJURY OR DAMAGE

- **NEVER** adjust the force settings to adjust for damage, including an unbalanced door, binding door track or broken spring.
- Perform a CONTACT REVERSE TEST monthly.

AVERTISSEMENT

Pour éviter les blessures ou des dommages

- **NE JAMAIS** régler la force pour compenser des dommages, y compris une porte mal équilibrée, un rail de porte coincant ou des ressorts cassés.
- Tous les mois, EFFECTUEZ LE TEST D'INVERSION AU CONTACT.

1. Press and release the Wall Control button and allow the garage door to travel and stop at the DOWN limit.
2. Press and release the wall control button and allow the garage door to travel and stop at the UP limit.

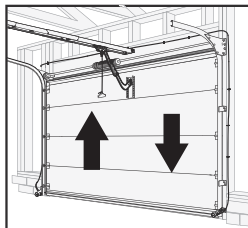
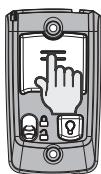

Force Control Adjustments

Force settings are programmed from the factory to remain within safe parameters. These should not require adjustments. However, certain circumstances may require adjustment.

Refer to the "SPECIAL INSTALLATION INFORMATION" section to adjust the force settings.

Contact Reverse Test

NOTE: The limit and Force settings **MUST BE COMPLETED** before performing the Contact Reverse Test.

1. With the garage door open, lay a 2 X 4 board flat on the floor at the center of the door opening.
2. Close the garage door using the wall control.

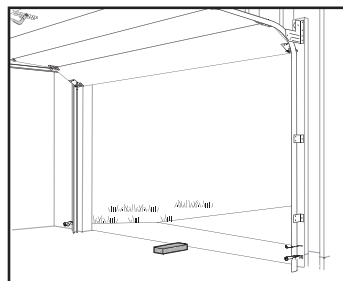
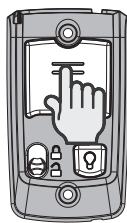

- When the door contacts the board, it should stop and reverse direction within 2 seconds to the full open position.
- The long LED light on the powerhead will begin to flash RED with the reversal of the door.
- Remove the 2" x 4" board and operate the opener with the wall control again. This cycle will clear the flashing red LEDs.

Contact Reverse Adjustment

If the door stops before contacting the board or if it does not reverse direction to fully open after contact with the board, it may be due to an improperly set DOWN limit. Verify settings by:

1. Repeat the "Down Travel Limit" section to make certain the door is closing tight against the floor.
2. Repeat the "Force Control" section on the left to set force limits.
3. Repeat the "Contact Reverse Test" above.

Repeat this process as needed until the door passes the Contact Reverse Test.

Refer to the "SPECIAL INSTALLATION INFORMATION" section to adjust the force settings.

PROGRAM ADDITIONAL REMOTE CONTROLS

THE REMOTE CONTROLS INCLUDED WITH THIS OPENER MAY HAVE BEEN PROGRAMMED AT THE FACTORY FOR YOUR CONVENIENCE.

NOTE: The following instructions are for remote control transmitters purchased separately in addition to those provided with this opener, but can also be used if any remote(s) may require re-programming.

NOTE: Each programming step has a 30 second time limit for completion after the function is initiated. After 30 seconds, two LED's will illuminate RED indicating time has expired and the step must be re-started. Restart the step as many times as necessary to complete the programming.

NOTE: Do not hold remote too close to the powerhead when programming remote buttons.

NOTE: Each button on each remote must be programmed separately, following these steps.

1. Remove the battery's protective film from the remote by pulling straight down.
2. Press and hold the PRGM/SET button on the opener for two seconds.
 - The ROUND LED will turn BLUE.
 - The LONG LED will then flash PURPLE.
3. Stand at least 5 feet away from opener and slowly press and release the desired button on the remote two times.
 - Both opener LEDs will flash and turn off indicating the remote has been programmed.
4. Press the desired remote button again.
 - The opener should run.

To program the same remote for other garage door opener, repeat the steps above using one of the other remaining remote buttons.

REPEAT STEPS 1 TO 4 FOR EACH OPENER AND REMOTE

NOTE: It is possible to press the remote button too quickly or lightly. If the LEDs do not go off, press the remote button several more times to achieve confirmation.

BASIC PROGRAMMING IS COMPLETE AND YOUR GARAGE DOOR OPENER IS READY TO USE.

Refer to the "SPECIAL INSTALLATION INFORMATION" section to erase remote devices from memory.

1. Activate Remote

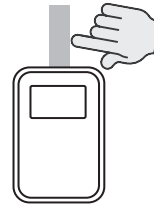

2. Enter Programming Mode

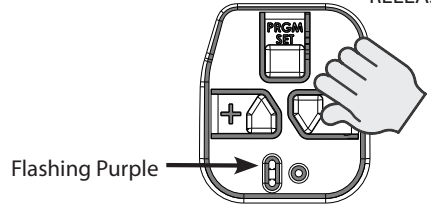
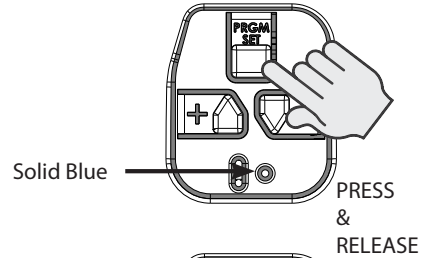

3. Press Remote Button Twice

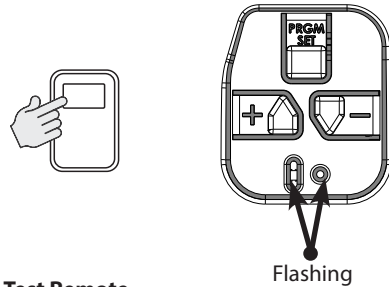

4. Test Remote

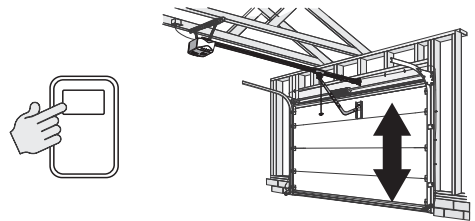

PROGRAM WIRELESS WALL CONSOLE

Included with select models

QuickView setup.

Please see complete instructions that accompany Wireless Wall Console

STEP 1) Program Wireless Wall Console to Garage Door Opener

Open console cover and remove battery tab before programming.

Place opener into remote control programming mode (SEE PAGE 10):

1. Press and hold the program button on the opener until the round LED turns blue, then release.
2. The round LED will go out and the long LED will begin flashing purple.
3. Press the DOOR button on the WALL CONSOLE 3 times or until door operates.

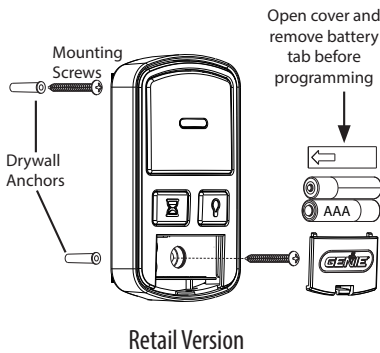

Retail Version

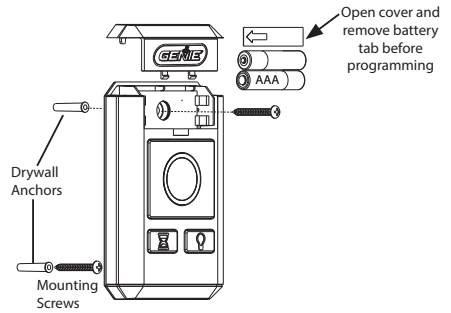

Pro Version

STEP 2) Operating the Door with Wall Console

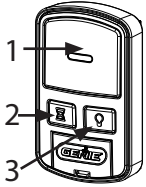

1. DOOR Button - Runs garage door opener.
2. DELAY Button - Each press adds a 10 second delay for door operation (up to 3 times for up to 30 sec.). Press the delay button and door will automatically operate after set delay.
3. LIGHT Button - Overrides the automatic timed light function of the garage door opener.

STEP 3) Mounting the Wall Console

The Wall Console MUST be mounted within sight of the garage door(s) at least five feet above the floor and clear of any moving door part. Use UNINTENDED OPERATION decal in lieu of standard console warning decal.

1. Remove battery cover and batteries.
2. Drill 3/32" pilot hole for the slotted mounting hole screw (included) or 5/32" if using drywall anchors.
3. Install a screw into the pilot hole, leaving a 1/8" gap between the screw head and wall.
4. Hook the slotted mount, on back of console, over the screw.
5. Mark and drill a pilot hole for the screw under the battery cover (included) and secure console to wall
6. Reinstall batteries and cover.

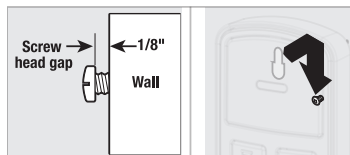
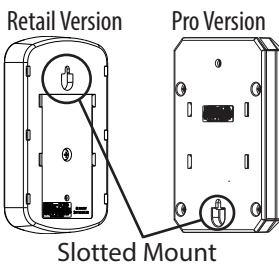

Apply unintended operation decal next to wall console.

PROGRAM WIRELESS KEYPAD (abbreviated)

QuickView Single Door setup.

Please see complete instructions that accompany keypad

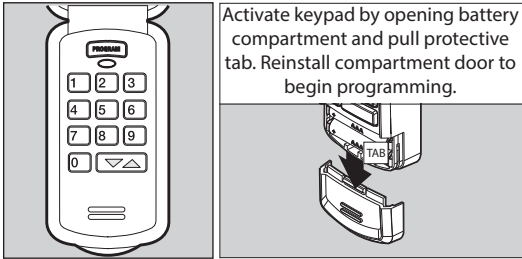

Program Keypad before mounting.

STEP 1) PROGRAMMING A PIN NUMBER (Single Door)

The existing factory default Personal Identification Number (PIN) for this keypad is the number sequence: 3-5-7

Sync the opener and the keypad by performing the following:

1. Ensure the keypad back lighting is off.
2. Place garage door opener into remote control PROGRAMMING MODE (SEE PAGE 10).
3. Press 3-5-7 in sequence on the keypad.
4. Press the UP/DOWN key 3 to 4 times slowly until garage door opener operates.
 - This completes the programming of a single door opener (door 1) and keypad.
 - *IT IS RECOMMENDED THAT YOU CHANGE THIS PIN FROM THE EXISTING FACTORY DEFAULT SETTING OF 3-5-7. See STEP 2 below.*

STEP 2) CHANGING DEFAULT PIN OF 3-5-7

1. Enter the factory default pin of 3-5-7.
2. Press PROGRAM key once.
3. Enter a new PIN of your choice (3-8 digits).
4. Press PROGRAM key once.
 - *Your PIN has been changed and your previous PIN will no longer operate the keypad or opener.*

STEP 3) OPERATING THE KEYPAD WITH THE OPENER

Single Door Operation:

1. Ensure number pad back lighting is off.
2. Enter PIN number.
3. Press the UP/DOWN key.
4. Opener will operate.

NOTE: Keypad will remain active for 15 seconds after a successful entry is made. During this 15 seconds ANY key will operate the opener.

Resetting a PIN:

Press and hold both the **PROGRAM** key and the Up/Down key for about five seconds.

The LED's will slowly blink and then go out. When the LED stops blinking, the old programming has been successfully erased.

To create a new PIN, start with STEP 1.

Mounting Keypad

The keypad **MUST** be mounted within sight of the garage door(s) at least five feet above the floor and clear of any moving door part.

1. Remove battery cover and batteries.

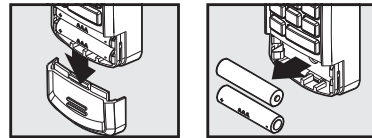

2. Drill 3/32" pilot hole for the top mounting screw (included).
3. Install a screw into the pilot hole, leaving a 1/8" gap between the screw head and wall.

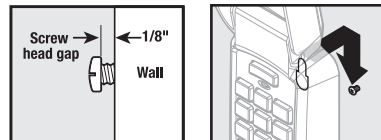

4. Hook the slotted mount, on back of keypad, over the screw.

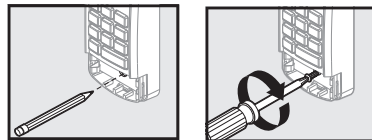

5. Mark and drill a pilot hole for the bottom screw (included) and secure keypad to wall (DO NOT overtighten).
6. Reinstall batteries and cover.

PROGRAM VEHICLE CONTROLS (abbreviated)

Programming HomeLink® System

Step 1) Clear HomeLink

Clear HomeLink by pressing and holding down the first and third buttons until the indicator on the HomeLink blinks slow and then fast for 20 seconds; then release both buttons.

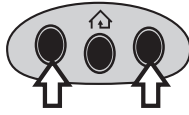

NOTE: *Clearing the HomeLink will remove all previously programmed garage door openers.*

Step 2) Train HomeLink to the Remote

Choose the button on the HomeLink that will be used to open the door.

NOTE: *Hold the Remote two inches from the HomeLink button.*

Hold down the remote button. While holding, press and hold the chosen HomeLink button.

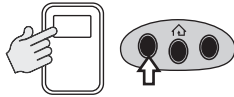

Hold down both buttons until the indicator on the HomeLink blinks slow then fast. Once it blinks, release both buttons.

Step 3) Program HomeLink to the Opener

(Place opener into programming mode) - SEE PAGE 10

A. Press the chosen HomeLink button for two seconds and release. Press that same button again for two seconds and release. The long LED will flash blue and then turn off.

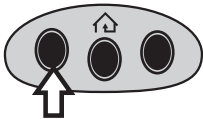

B. Press the HomeLink button a few more times until door moves.

NOTE: *For additional instructions, see the motor vehicle manual, or visit www.homelink.com or visit www.geniecompany.com*

NOTE: *Some vehicles require HomeLink to be purchased and/or activated by the car dealership.*

Programming Car2U® System

Step 1) Clear Car2U to default settings

The default setting for the Car2U system is:

- Button 1 = Genie® Manufactured Openers
- Button 2 = LiftMaster® Manufactured Openers

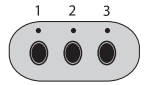

- Button 3 = Wayne Dalton® Manufactured Openers

- Press and hold buttons 1 and 3 for 20 seconds or until all three LEDs begin to flash.
- Release both buttons. The Car2U system is now set to the Factory Default settings

NOTE: *Clearing the Car2U remote will remove all previously programmed garage door openers.*

Step 2) Program Car2U to the Opener

(Place opener into programming mode) - SEE PAGE 10

- Press the designated Car2U button for two seconds and release. Press that same button again for two seconds and release. The long LED will flash blue and then turn off.
- Press the Car2U button a few times more until door moves.

Step 3) Changing Factory Default Button for a Genie® Opener

- Press and hold buttons 1 & 3 for **ONE SECOND** and release—all three LEDs will light solid red.
- Press and hold the button (2 or 3) to change it to—the corresponding LED will flash. While continuing to hold that button, press and release button 1. Press and release button 1 again.
- Release the button being held in step B and wait for the LED to stop flashing. This button is now set. Repeat Step 2 for second Opener.

NOTE: *For additional instructions see the motor vehicle manual, learcar2u.com.*

SETTING UP ALADDIN CONNECT®

Perform these steps only after opener is fully installed, programmed and tested.

IMPORTANT SAFETY INSTRUCTIONS

WARNING

TO REDUCE THE RISK OF SEVERE INJURY OR DEATH, READ AND FOLLOW ALL INSTRUCTIONS.

1. Never allow children to operate or play with door controls.
2. Install the entrapment WARNING placard next to the wall control in a prominent location.
3. NO PERSONS SHOULD CROSS THE PATH OF A MOVING DOOR.
4. NEVER GO UNDER A STOPPED/PARTIALLY OPEN DOOR.
5. The Aladdin Connect® operating system is designed for unattended operation. The door could move unexpectedly.

SAVE THESE INSTRUCTIONS

CONSIGNES DE SÉCURITÉ IMPORTANTES

AVERTISSEMENT

POUR RÉDUIRE LE RISQUE DE BLESSURES GRAVES VOIRE MORTELLES, LIRE ET COMPRENDRE TOUTES LES INSTRUCTIONS.

1. NE JAMAIS laisser les enfants utiliser ou jouer avec les commandes de l'ouvre-porte.
2. Placer l'étiquette d'AVERTISSEMENT en cas de coinçage à proximité du bouton mural ou de la console murale de manière à ce qu'elle soit bien en évidence.
3. NE JAMAIS PASSER SOUS LA PORTE EN MOUVEMENT.
4. NE JAMAIS PASSER SOUS UNE PORTE À L'ARRÊT PARTIELLEMENT OUVERTE.
5. Le système d'exploitation Aladdin Connect™ a été conçu pour fonctionner sans surveillance. La porte peut se déplacer de façon inattendue.

CONSERVER CES INSTRUCTIONS

Genie® Integrated Aladdin Connect® Models

The Aladdin Connect® system is a convenient mobile device app to operate garage door openers/controllers from anywhere.

The Aladdin Connect® app has the following features:

- Customize access for different users.
- Customize notifications to receive alerts when the garage door is operated, by a specific user, at a specific time or day.
- Review history of opener usage showing dates and times when the opener was operated and by what user.
- Create custom rules to notify you or close the door at specific times or if your door is open for a specific duration.
- Connect your opener to operate with smart home platforms.

1 Check Wi-Fi Signal

Before beginning the set-up process please verify the ability to receive a strong Wi-Fi signal in the garage. Connect smartphone to the home Wi-Fi and walk into the garage. Place phone where garage door opener will be mounted. The Wi-Fi signal strength at that location must be at least two bars.

If home Wi-Fi signal does not adequately cover the garage, try the following steps to help improve the signal strength.

- Make sure that the Wi-Fi router is out in the open, not behind a large electronics or in a cabinet.
- Moving the Wi-Fi router closer to the garage.
- Purchase a Wi-Fi extender, available at most electronics stores.

Device Wi-Fi Signal strength indicator



2

Download the Aladdin Connect® app (Unless using 3rd party app)

Scan for iOS app



Apple and the Apple logo are trademarks of Apple Inc., registered in the U.S. and other countries. App Store is a service mark of Apple Inc.

Scan for Android app



3

Follow the Aladdin Connect® app instructions

Follow steps per the app instructions.

- Create an account
- Add a device
- Set up Wi-Fi
- Add users and rules

For help at any time contact The Genie Company at 1-866-599-4995 or visit our website. www.geniecompany.com/aladdinconnect



Scan the Aladdin Connect® QR Code on the front of this manual or on the powerhead when prompted by the Aladdin Connect® app.

4

Install WARNING placard

Place the included unattended operation warning placard next to the garage door opener's wall button.

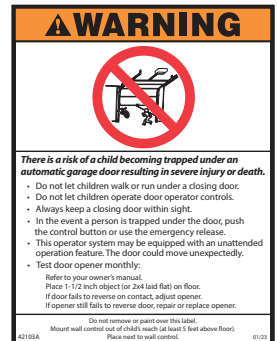

NOTE: Use of this product, the software embedded within this product and the related application software is subject to the Terms and Conditions available at: www.geniecompany.com/aladdinconnect

Force Adjustment Guide:



WARNING

TO AVOID INJURY OR DAMAGE

- **NEVER** adjust the force settings to adjust for damage, including an unbalanced door, binding door track, or broken spring.
- Perform a CONTACT REVERSE TEST monthly.



AVERTISSEMENT

Pour éviter les blessures ou des dommages

- **NE JAMAIS** régler la force pour compenser des dommages, y compris une porte mal équilibrée, un rail de porte coincant, ou des ressorts cassés.
- Tous les mois, EFFECTUEZ LE TEST D'INVERSION AU CONTACT.

Force Settings:

Force settings are pre-programmed at the factory and applied during the Open/Closed Limit settings steps. For normal use, these settings should not need adjustment.

Conditions possibly requiring adjustments are:

- Doors with very stiff weather seals.
- Doors that start down, STOP, and reverse before closing.
- Doors that start up, but STOP before they completely open.

1. **Press and hold** both UP & DOWN arrow buttons until the ROUND LED turns RED. Release buttons.
 - LEDs will show current force level. SEE CHART.
2. Press either the UP or DOWN arrow button until the desired UP force setting is shown. SEE CHART.
3. Press the PRGM button to lock the desired UP FORCE setting.
 - LEDs will now show the current DOWN FORCE setting. SEE CHART.
4. Press either the UP or DOWN arrow button until desired DOWN force setting is shown. SEE CHART.
5. Press the PRGM button to lock the desired DOWN FORCE setting.
 - Both LEDs will turn BLUE then go out confirming that the force settings have been changed and are locked.
6. Opener is now ready to operate and test.
7. Operate door from the wall console two full cycles then perform safety contact reverse test.

FORCE SETTING CHART

Force Level	Long LED	Round LED
1 (LOWEST)	OFF	BLUE
2	BLUE	OFF
3	BLUE	BLUE
4	OFF	VIOLET
5	VIOLET	OFF
6	VIOLET	VIOLET
7	OFF	RED
8	RED	OFF
9 (HIGHEST)	RED	RED

PRESS & RELEASE

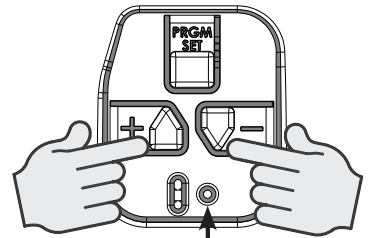

Flashing RED

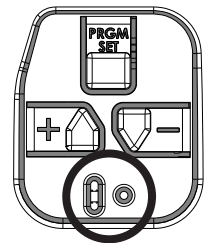

See Chart for Force level indicators.

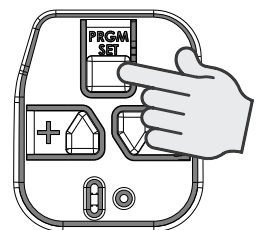

Press PRGM to lock settings

CLEARING MEMORY OF REMOTES & WIRELESS WALL CONSOLE

NOTE: Clearing memory of remotes from the powerhead will clear ALL programmed remotes, wireless keypads and vehicle transmitters. The opener will no longer recognize any signal from any remote device, including a missing remote device. This does not include Aladdin Connect®.

All remaining (or recovered) remotes, vehicles and wireless keypads MUST be reprogrammed.

NOTE: The garage door opener will operate normally using the wired wall console, if applicable.

1. Press and hold the SET/PRGM button until the ROUND LED turns BLUE, then release. The LONG LED will then flash PURPLE.
2. To clear all RF devices, except the Wireless Wall Console, when used (transmitters/keypads/HomeLink/Car2U):
 - Press and hold both the UP & DOWN buttons at the same time until both LEDs turn BLUE.
 - Release to erase RF devices.
3. And/or, to clear ONLY the Wireless Wall Console:
 - While in programming mode, press and hold both the UP and DOWN buttons at the same time until both LEDs turn GREEN.
 - Release to erase the Wireless Wall Console.
4. Press any remote button. The operator should NOT run.

1. Enter Programming Mode

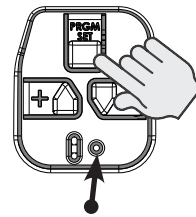

Solid Blue

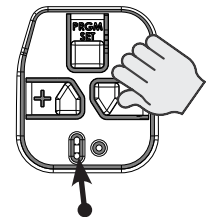

Flashing Purple

2. Press and Hold + & - Buttons

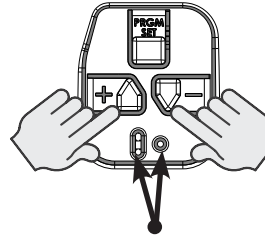

Solid Blue



Release when LEDs turn off

3. Press and Hold + & - Buttons

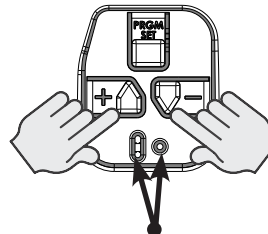

Solid Green



Release when LEDs turn off

Chain/Belt Adjustments for Tube Type Rails:

NOTE: Might be necessary after unit is installed and run for the first time.

If excessive chain/belt sag is noticed below the rail:

1. Open the door until carriage is about mid travel and stop.
2. Disengage the carriage and manually close the door.
3. Loosen nuts on turnbuckle using 7/16" wrenches.
4. Rotate turnbuckle counter-clockwise until slack is removed from chain/belt.
5. When measured on the opposite side of the rail from the turnbuckle, a properly adjusted chain/belt will have a 1/4" gap to the bottom of the rail.
6. Tighten nuts to secure turnbuckle.
7. Be sure that chain/belt is not twisted or bound.
8. Manually open door to re-engage carriage to turnbuckle.

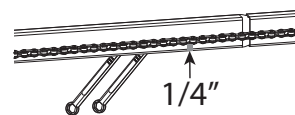
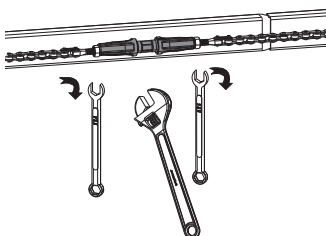

Location of Safe-T-Beam Pairs

This view is looking down at the garage from above, with the dotted lines representing the garage door opening.

- The Safe-T-Beam sensor with the RED LED is the transmitting device. The Safe-T-Beam sensor with the GREEN LED is the receiving device.
- On doors that are right next to each other, always place the RED sensors facing in opposite directions of each other. The pattern should look like the image below.

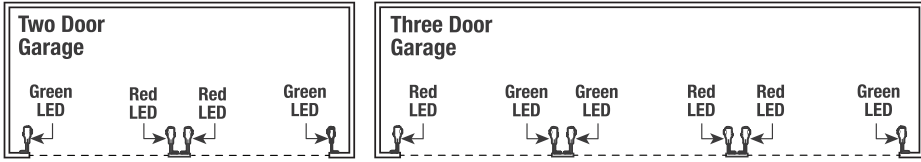

Dealing with Sunlight Interference

This view is looking down at the garage from above.

- Direct sunlight can create interference with the GREEN Safe-T-Beam sensor and cause the opener to detect an obstruction.
- Determine which side of the garage receives direct sunlight and position the RED sensor on that side.
- Sensors can be positioned further away from the door opening if necessary to avoid sunlight, but be sure to maintain alignment with the other sensor.

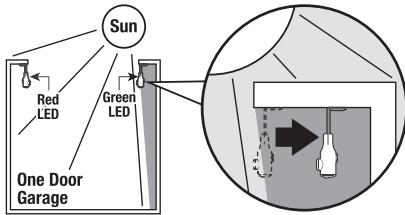

NOTE: Only use Safe-T-Beam sensors that are included with this opener. **DO NOT** use other brands or types of safety sensors on this opener.

Safe-T-Beam® Self-Diagnostic Troubleshooting Chart

RED LED	Green LED	Possible Problem	Solution
ON	ON	Normal Operation	None Required
OFF	OFF	<ul style="list-style-type: none"> • Opener not powered • Wiring from opener bad 	<ul style="list-style-type: none"> • Check breakers, fuses, plugs • Check wiring for shorts
OFF	ON	<ul style="list-style-type: none"> • Wiring to source missing or bad • Power has been interrupted 	<ul style="list-style-type: none"> • Check wiring • Remove power and reapply
2 BLINKS	ON	<ul style="list-style-type: none"> • Beam not aligned • Beam obstructed • Sensor defective 	<ul style="list-style-type: none"> • Check source, Sensor alignment • Check for obstruction • Contact Customer Support
2 BLINKS	OFF	<ul style="list-style-type: none"> • Wire to sensor missing or bad • Sensor defective 	<ul style="list-style-type: none"> • Check wiring • Contact Customer Support
3 BLINKS	ON	<ul style="list-style-type: none"> • Sensor receiving interference 	<ul style="list-style-type: none"> • Determine source of interference • Contact Customer Support
4 BLINKS	ON	<ul style="list-style-type: none"> • Defective source beam (RED LED) 	<ul style="list-style-type: none"> • Replace Safe-T-Beam set

When the garage door is up and something breaks the beams, the opener worklight turns on.

To turn STB Worklight function ON/OFF:

1. Unplug the power cord from the outlet and disconnect the Battery Backup, if Installed.
2. Press and hold the "DOWN" arrow (-) while plugging in the opener, then release.
3. Repeat to toggle ON/OFF.

Installing Battery Backup

Perform these steps only after the opener is fully installed, programmed, and tested.

Battery backup devices from other manufacturers will not operate with this opener.
Use only the Genie (OEM) product provided and other OEM replacement products.

⚠ CAUTION

TO PREVENT POSSIBLE SERIOUS INJURY or DEATH from electrocution AND REDUCE RISK of FIRE

-Disconnect ALL electric power sources and battery power BEFORE performing ANY service or maintenance.

Install only in DRY locations - NOT INTENDED FOR OUTDOOR USE.

Use only 12V, 5AH, SLA replacement battery. (P/N 111658.0002.S).

⚠ ATTENTION

POUR ÉVITER LES BLESSURES GRAVES OU LA MORT par électrocution ET RÉDUIRE LE RISQUE D'INCENDIE

-Débrancher toutes les sources d'alimentation électrique et la pile AVANT d'effectuer des opérations de réparation ou d'entretien.

Installer uniquement dans des endroits SECS - NE DOIT PAS ÊTRE UTILISÉ À L'EXTÉRIEUR.

Utiliser uniquement une pile de remplacement de 12V, 5AH, SLA. (P/N 111658.0002.S).

Single Bulb Models with External Battery Backups:

1. Unplug powerhead from power source.
2. Attach BBU assembly next to the opener and install mounting screws to ceiling or framing.
3. Plug battery harness into plug located at the top of the powerhead.

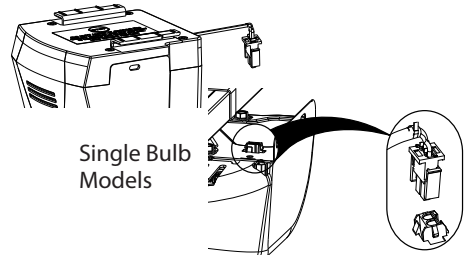

Dual Bulb or Integrated LED Models with External Battery Backups:

1. Unplug powerhead from power source.
2. Tilt BBU approximately 45° and lower into slots in the top rear of the powerhead.
3. Fasten to powerhead with 2 supplied self tapping screws, and reconnect powerhead to power source. Self tapping screws will self tap through the cover (there are no holes in rear cover).

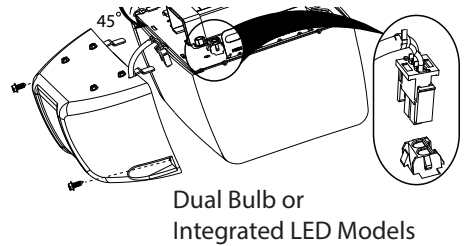

See the troubleshooting section for condition LED's that will illuminate once the Battery Backup is operational.

Both LEDs will signal solid GREEN under normal, fully charged, conditions.

Testing The Genie Battery Backup

NOTE: It is recommended to charge the battery backup for 48 hours prior to testing. Initially, the opener may not operate from the battery backup mode if battery is not fully charged.

1. Turn off power to opener by unplugging from outlet or turning off breaker.
2. Press wall control or remote control.

NOTE: Opener will run at a reduced speed when operating from battery backup.

NOTE: See troubleshooting guide in this manual if any of the steps above fail.

Work light will not operate while in battery backup mode. (Courtesy white LED's will illuminate.)

3. After successful test, reconnect powerhead to power source.

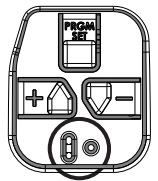

IMPORTANT SAFETY INSTRUCTIONS**⚠ WARNING**

To reduce the risk of severe injury or death, read and follow all instructions.

- 1. NEVER** let children operate or play with the door controls.
- Keep remote away from children.
- 3. ALWAYS** keep the moving door in sight and away from people and objects until door is completely closed. **NO ONE SHOULD CROSS THE PATH OF THE MOVING DOOR.**
- 4. NEVER** GO UNDER A STOPPED, PARTIALLY OPEN DOOR.
- Test opener monthly. The door **MUST** reverse on contact with a 1-1/2" high object (or 2" x 4" board laid flat) at the center of the doorway on the floor. After adjusting either the force or limit of travel, retest door opener. Failure to adjust the opener properly may cause severe injury or death.
- When possible, use emergency release only when door is closed. Use caution when using this release with the door open. Weak or broken springs are capable of increasing the rate of door closing and increasing the risk of severe injury or death.
- 7. KEEP DOORS PROPERLY BALANCED.** See your garage door Owner's Manual. An improperly balanced door increases the risk of severe injury or death. Have a trained door system technician make repairs to cables, spring assemblies, and other hardware.

SAVE THESE INSTRUCTIONS

IMPORTANTES CONSIGNES DE SÉCURITÉ**⚠ AVERTISSEMENT**

Pour réduire le risque de blessures graves voire mortelles, lire et comprendre toutes les instructions.

- 1. NE JAMAIS** permettre aux enfants d'actionner ou de jouer avec les commandes de la porte.
- Tenir les télécommandes hors de la portée des enfants.
- 3. TOUJOURS** garder en vue la porte en mouvement et tenir à l'écart toute personne ou objet jusqu'à ce que la porte soit totalement fermée. **PERSONNE NE DOIT TRAVERSER LA TRAJECTOIRE D'UNE PORTE EN MOUVEMENT.**
- 4. NE JAMAIS** PASSER SOUS UNE PORTE À L'ARRÊT PARTIELLEMENT OUVERTE.
- Tester l'ouvre-porte une fois par mois. La porte de garage **DOIT** inverser sa course au contact d'un objet de 4 cm (planche de 5 sur 10 cm) posé à plat sur le sol au centre de l'ouverture de la porte. Après avoir réglé la force ou la limite de la course, retester l'ouvre-porte de garage. Un mauvais réglage de l'ouvre-porte peut entraîner des blessures graves voire mortelles.
- Utiliser, dans la mesure du possible le déclenchement d'urgence uniquement lorsque la porte est fermée. Utiliser le déclenchement d'urgence avec prudence lorsque la porte est ouverte. Des ressorts faibles ou brisés peuvent faire descendre la porte rapidement ce qui peut entraîner des blessures graves voire mortelles.
- 7. VEILLER À CE QUE LA PORTE SOIT CORRECTEMENT ÉQUILIBRÉE.** Consulter le manuel du propriétaire de la porte de garage. Une porte déséquilibrée pourrait entraîner de graves blessures voire mortelles. Demander à un technicien spécialisé en système de portes de se charger des réparations des câbles, des ressorts et de toute autre quincaillerie.

CONSERVER CES INSTRUCTIONS

⚠ WARNING

Use of any other wall control can cause unexpected operation of the door and loss of lighting feature. Locate wall console within sight of the door but far enough from door to prevent contacting it while operating the console. Control must be at least 5 feet above the floor to prevent small children from operating it.

⚠ AVERTISSEMENT

L'utilisation d'une autre commande murale pourrait produire des résultats inattendus de la porte ainsi que le dysfonctionnement de l'éclairage. Localisez la console murale en vue de la porte et suffisamment loin de la porte pour éviter tout contact pendant l'utilisation de la console. La commande doit être à une hauteur minimale de 1,5 m au-dessus du sol afin que les jeunes enfants ne puissent pas l'atteindre.

Regular Maintenance Schedule

Regular inspection/maintenance for the door and opener should be performed at regular intervals to ensure the system runs at peak safety, performance, and efficiency.

MAINTENANCE ITEM	INTERVALS	DETAILS
Contact Reverse Test	Monthly	See Page 9 to run system test.
Lubricate Door Hardware	Monthly	Lubricate Rollers & Hinges with a light weight general purpose grease.
Safe-T-Beam® system check	Monthly	Check wiring for loose connections, cracks or worn insulation. Clean lenses of dirt & debris.
Door Balance	Monthly	See Maintenance Detail below
Battery Backup System	Monthly	Unplug opener from outlet. Test opener with remote or wall console. Replace battery if needed. See page 19.
Chain/Belt Adjustments	Yearly	Inspect chain/belt for excessive slack, adjust as necessary.
Remote Battery Replacement	As Needed	See Maintenance Detail next page
Light Bulb Replacement	As Needed	See Maintenance Detail next page

Door Inspection and Maintenance

Perform the Door inspection as follows:

With the door closed, pull manual emergency release handle DOWN and away from door and let go to disengage the carriage from the drive chain or belt FIG.1.

- Raise and lower the door manually. Door should move freely and smoothly.
- Raise door manually about 3' to 4' feet from floor and let go.. Door should remain stationary or slowly drift closed. FIG. 1.
If door opens or closes rapidly, **CONTACT A TRAINED DOOR SYSTEM TECHNICIAN** to have your door springs serviced.
- Close the door.

Carriage Adjustment (Release/Engagement)

- Place the carriage in the "engage" position reverse of FIG. 2.
- Operate door using remote or wall control. The carriage will reattach itself to the drive chain/belt.

⚠ WARNING

- Garage door hardware (springs, cables, brackets, pulleys, etc.) are under extreme pressure and tension.
- **DO NOT** attempt to repair or adjust door springs or any hardware, and **DO NOT OPERATE** garage door automatically or manually if door is improperly balanced or springs are broken.
- **CONTACT A TRAINED DOOR SYSTEM TECHNICIAN.**

⚠ AVERTISSEMENT

- La quincaillerie de la porte de garage (ressorts, câbles, supports, poulies, etc.) sont sous des pressions et des tensions extrêmes.
- **NE PAS** réparer ni régler les ressorts de la porte ou toute autre pièce de quincaillerie et **NE PAS ACTIONNER** la porte manuellement ou automatiquement si elle n'est pas correctement équilibrée ou si des ressorts sont cassés.
- **CONTACTEZ UN TECHNICIEN SPÉCIALISÉ EN SYSTÈME DE PORTES**



FIG.1

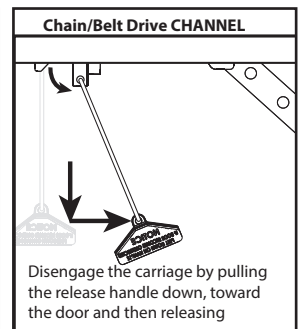
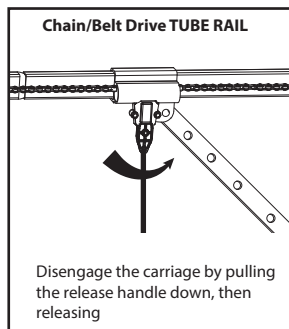
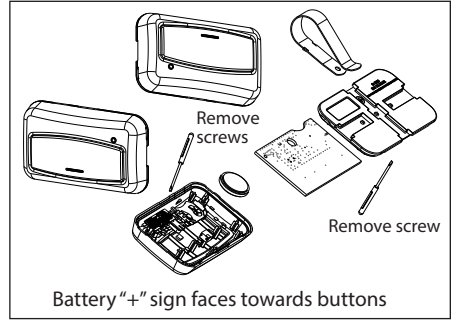
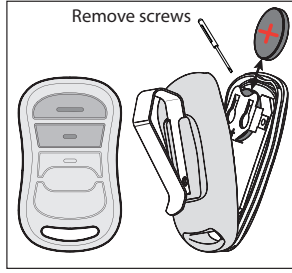
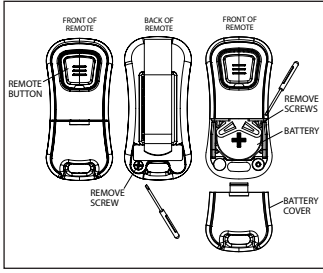

FIG 2

DO NOT use release cord to pull door.

Remote Battery Replacement

Use a screwdriver and/or a small coin to remove screws and open case as shown. Remove and replace CR2032 coin cell battery.



NOTE: Battery "+" sign orientation

Lightbulb Replacement

⚠ WARNING

- Use extreme caution when working from a ladder or step stool or serious injury can occur.
- When replacing light cover, make sure wires are not pinched or near moving parts.
- Use only properly rated incandescent, LED or CFL light bulbs.
- DO NOT use bulbs with a rating greater than 60 Watts.
- Use A19 size light bulbs. DO NOT use bulbs having a short neck.

⚠ AVERTISSEMENT

- Faire particulièrement attention lors de travaux effectués depuis une échelle ou en escabeau.
- En referment le couvercle de l'éclairage, s'assurer que les fils ne sont ni coincés ni près des pièces mobiles.
- Utilisez uniquement incandescence correctement classé, LED ou des ampoules fluocompactes.
- NE PAS utiliser des ampoules avec une note supérieure à 60 Watts
- Utilisez A19 ampoules de taille. NE PAS utiliser des ampoules ayant un cou court.

1. Disconnect power to opener.
2. Open powerhead lens covers by pressing down on upper locking tabs and pull away from powerhead.
3. Replace old light bulbs with 60 Watt MAXIMUM incandescent, CFL or LED equivalent**.
- * Genie LED light bulbs, which are specifically made for garage door openers, are recommended.
4. Install lens cover(s).
5. Reconnect power to door opener.
6. Test light operation.

NOTE: Use of standard LED bulbs may reduce the range of your remote controls*.

1 Light Models

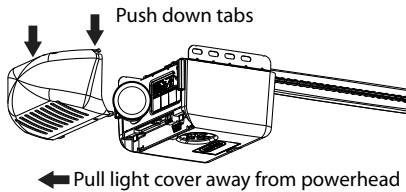

2 Light Models

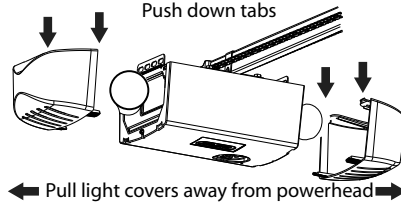

Models equipped with integrated LED lighting require specialty kits available for order in the replacement parts section.

**Integrated Aladdin Connect® models require a MINIMUM 40 Watt or equivalent bulb, 60 watt maximum.



* Genie LED light bulbs are designed to reduce or eliminate reduced remote range issues caused by common LED bulbs. They also offer better product life by making them resistant to vibration caused by the opener, and cold or damp weather. See website for details at www.geniecompany.com.

Use the guide below along with the self diagnostic powerhead LEDs to help troubleshoot any problems.



Need help or have questions? **DO NOT RETURN** to the store.

Visit www.geniecompany.com or call Customer Service at 1-800-35-GENIE.

Opener does NOT operate when wall control is pressed.	<ul style="list-style-type: none"> • Turn Sure-Lock™ OFF See page 5. • Check power source. <ul style="list-style-type: none"> – Plug a lamp into outlet used for powerhead. If lamp works, power source is OK. – If not, check fuse or circuit breaker. • If power is OK, <ul style="list-style-type: none"> – Check connections at powerhead terminals and at wall console. • Check for reversed, broken or cut wires. Staples can cut insulation and short wires. Repair or replace.
Opener runs, but door does not move.	<ul style="list-style-type: none"> • Make sure carriage is engaged with chain/belt turnbuckle. Refer to installation poster or download poster from www.geniecompany.com • Check to make sure chain/belt is not broken or off its pulley.
Opener works from wall control, but NOT from remote.	<ul style="list-style-type: none"> • Check all remotes. • Replace remote battery. See page 22. • Program remotes to powerhead. See page 10.
Remote has less than 25 feet operating range or no operation.	<ul style="list-style-type: none"> • Relocate remote inside car and /or point remote at garage door. • Replace battery. See page 22. • Reposition door opener antenna. • Eliminate possible competing signals (radio, etc.). • LED bulbs may be interfering with remote signal. See page 22.
Door starts down, then STOPS and goes back up. OR Safe-T-Beam® System malfunction.	<ul style="list-style-type: none"> • If a NEW installation, check Door Arm position. Refer to Installation poster or download poster from www.geniecompany.com. • If NEW Installation, make sure ONLY the Safe-T-Beams® that came with this opener are installed. • Check if limits are properly set. See pages 7-8. Adjust limits as needed. • Check if Safe-T-Beam® red LED is flashing. See page 18, Safe-T-Beam® system check. • Check Safe-T-Beam® system for beam obstruction or misalignment of lenses. See page 18, Safe-T-Beam® system. • Check garage door for binding. See page 21. • If an operational problem exists, and opener will not close, the opener can be forced to close as follows: Press and hold the wall control button until door is completely closed. • Check for interference from adjacent Safe-T-Beam® units. See page 18. • Contact Genie at 1-800-35-GENIE.
Door starts down, then STOPS before it is closed. OR Door will only open.	<ul style="list-style-type: none"> • Check Safe-T-Beam® wire connection at powerhead and at STBs. See page 18, Safe-T-Beam® system check. • Check if limits are properly set. See pages 7-8. Adjust limits as needed. • Check CONTACT REVERSE. See page 9. • Check garage door for binding. See maintenance and adjustment. Page 21. • Check closing "FORCE" control. See page 9, or Force settings. Page 16.
Door starts up, but STOPS before it is completely open.	<ul style="list-style-type: none"> • Check if limits are properly set. See pages 7-8. Adjust limits as needed. • Be sure door, opener, springs are in good repair, properly lubricated and balanced. • Check closing/opening "FORCE" control. See page 9, or Force settings Page 16. • If you suspect a problem with the garage door hardware or springs, visit www.geniecompany.com and use the "dealer locator" to hire a local door service professional. <p>NEVER try to repair door hardware or springs yourself.</p>
Door will only run closed.	<ul style="list-style-type: none"> • Turn Sure-Lock™ OFF See page 5. • Check if limits are properly set. See pages 7-8. • Check door balance, condition, and door spring. See page 21. • Check opening "FORCE" control. See page 9, or Force settings. Page 16. • If you suspect a problem with the garage door hardware or springs, visit www.geniecompany.com and use the "dealer locator" to hire a local door service professional. <p>NEVER try to repair door hardware or springs yourself.</p>
Door opener starts for no reason.	<ul style="list-style-type: none"> • Button stuck on wall control or remote. • Was remote lost or stolen? Erase all remotes from powerhead memory and program new remotes. See page 17.
Noisy operation.	<ul style="list-style-type: none"> • Be sure all door fasteners are tight. • Be sure garage door is in good repair, properly lubricated and balanced. • Be sure opener is in good repair.
Door opener runs slow.	<ul style="list-style-type: none"> • Check operating condition of door. Door may need professional repair/adjustment. • Is this opener installed on a one-piece door? This opener is not designed to operate a one-piece door.

POWERHEAD LED SIGNALS

Powerhead LED		Possible Problem	Solution
Round LED	Long LED		
OFF	OFF	Normal operation.	None required.
		No response from unit.	Check power supply. Contact a trained door system professional.
ON/RED/ STEADY	ON/RED/ STEADY	Limits NOT set properly.	Re-program limits, see pages 7-8.
ON/RED/ FLASHING	ON/RED/ FLASHING	Program error.	Unplug unit, wait 5 seconds, plug in.
		Component failure.	Contact a trained door system technician.
ON/BLUE/ FLASHING	OFF	Remote NOT programmed.	Program remote, see page 10.
ON/PURPLE/ FLASHING	OFF	Remote NOT programmed.	Program remote, see page 10.
ON/RED/ FLASHING	OFF	Safe-T-Beam® physical obstruction.	Remote obstruction, recheck unit.
		Safe-T-Beam® signal interference.	Check alignment of Safe-T-Beam® pair and nearest other Safe-T-Beam® pair, see page 18.
OFF	ON/RED/ FLASHING	Door contact in UP or DOWN travel.	Remove obstruction.
		Door component failure detected.	Check door spring, track, rollers, hinges and fixtures.
OFF	ON/RED/ STEADY	Thermal cutout.	DO NOT unplug unit. Wait until LED clears before operating.
ON/PURPLE/ STEADY	ON/PURPLE/ STEADY	Component error.	Contact a trained door system technician.
OFF	ON/BLUE/ FLASHING	Door will not open.	Check Sure-Lock™. Sure-Lock™ should be OFF for normal operation (see page 5).
ON/PURPLE/ FLASHING	ON/PURPLE/ FLASHING	Radio receiver error.	Unplug the unit. Wait 5 seconds and plug the unit back in. If problems persist, contact a trained door system technician.

Battery Backup Troubleshooting LED Signals

ON/GREEN STEADY	ON/GREEN STEADY	OK=Charged, Battery Backup	None Required
ON/GREEN FLASHING	ON/GREEN FLASHING	Discharging, Battery Backup	Power is out. Battery in use.
ON/YELLOW FLASHING	ON/YELLOW FLASHING	Charging, Battery Backup	None Required
ON/RED TO YELLOW FLASHING	ON/RED TO YELLOW FLASHING	Dead Battery, Battery Backup	Allow to charge 48 hours. If charging fails, Replace Battery.
ON/WHITE STEADY	ON/WHITE STEADY	Battery Backup in Operation	No Fault. Courtesy light while in battery backup mode. Light will turn off after 4 minutes.

LED DISPLAY UNDER NORMAL OPERATING CONDITIONS

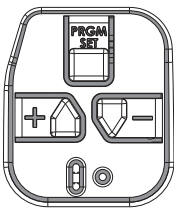

Standard Models
NO LED DISPLAY

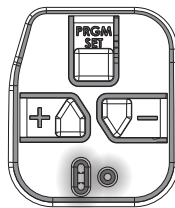

Battery Back-up Models
BOTH LEDs = STEADY GREEN

7 REPLACEMENT ASSEMBLY PARTS

Please have your specific opener model number (on opener powerhead) or serial number (front of this manual) when ordering parts.

TUBE RAIL PARTS ONLY

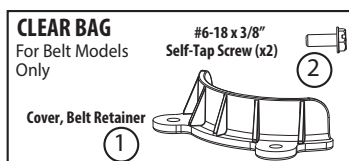
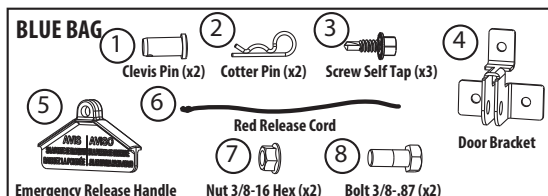
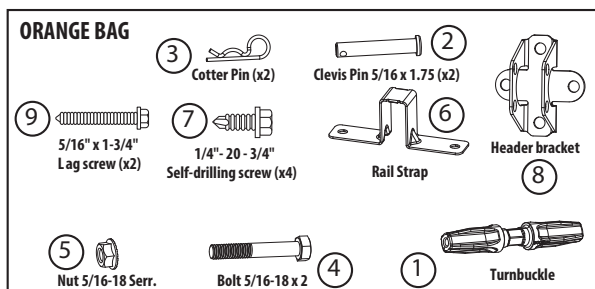

A 39010R.S PARTS PK, MOUNTING, ORANGE

Item #	Part Number	Description	Qty.
1	TURNBUCKLE	1	
2	PIN, CLEVIS, 5/16 X 1-3/4	2
3	COTTER, HAIRPIN, .0725 DI	2
4	BOLT, HH, PLD, 5/16-18 X 2	1
5	NUT, 5/16-18 HX SERR FLG	1
6	STRAP, RAIL, RECT	1
7	SCR, SERR HWH, AB, 1/4-14	4
8	BRKT, HEADER, RECT RAIL	1
9	SCR, LAG, HWH, TPG, 5/16" X1	2

B 39011R.S PARTS PK, MOUNTING, BLUE

Item #	Part Number	Description	Qty.
1	PIN, CLEVIS	2
2	PIN, COTTER	2
3	SCREW, SELF TAPPING 1/4-14 X 5/8	3
4	BRACKET, HEADER	1
5	EMERGENCY RELEASE HANDLE	1
6	EMERGENCY RELEASE CORD	2
7	NUT, FLANGE 3/8-16	2
8	BOLT, 3/8-16 X .87	2

D 39012R.S PARTS PACK, CLEAR, FOR BELT MODELS ONLY

Item #	Part Number	Description	Qty.
1	COVER, BELT RETAINER	1
2	SCR, SF TP #6-18 X 3/8	2

ALL RETAIL OPENERS

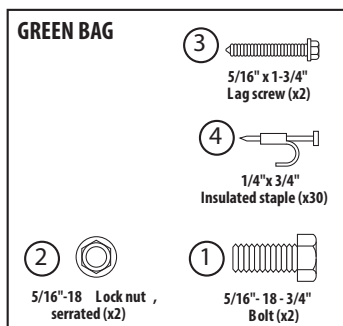

C 37105S.S PARTS PK, INSTALL, GREEN

Item #	Part Number	Description	Qty.
1	BOLT, HH, PLD, 5/16-18 X 3	2
2	NUT, 5/16-18 HX SERR FLG	2
3	SCR, LAG, HWH, TPG, 5/16" X1	2
4	PARTS PK, INSULATED STAP	30

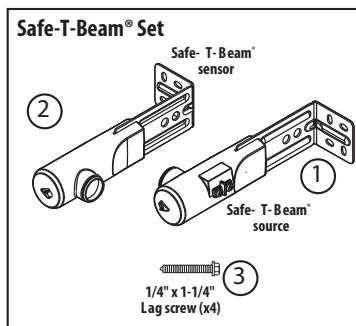

E 37220R Safe-T-Beam Set

Item #	Part Number	Description	Qty.
1	XMTR ASSY, STB1	1
2	RCVR ASSY, STB1	1
3	SCR, #10-16 X 1.25	4

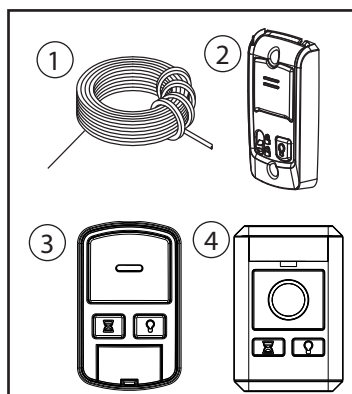

ACCESSORIES

Item #	Part Number	Description
1	35265B.S	90ft. LOW VOLTAGE WIRE SPOOL
2	39165R	WIRED WALL CONSOLE
3	41006R	WIRELESS WALL CONSOLE (RETAIL)
4	39902R	WIRELESS WALL CONSOLE (PRO)

REPLACEMENT POWERHEAD PARTS

Please have your specific opener model number (on opener powerhead) or serial number (front of this manual) when ordering parts.

Single Bulb Powerhead Models

Item	Description	QTY.
1	Powerhead cover	1
2	Lens cover	1
3	Motor assembly (includes encoder & wire)	1
4	Light socket assembly (regular bulb only)	1
5	Transformer, 120V	1
6	Circuit board assembly, main (identify green or blue color)	1
7	Circuit board assembly, Wi-Fi	1
8	Power cord assembly (identify 4' or 6')	1
9	Screws, motor (3pk; M6-1x12)	1
10	Screws, cover and/or transformer (3pk; #8x5/16)	1
11	Optical encoder replacement assembly	1
12	Bracket, Wi-Fi board	1

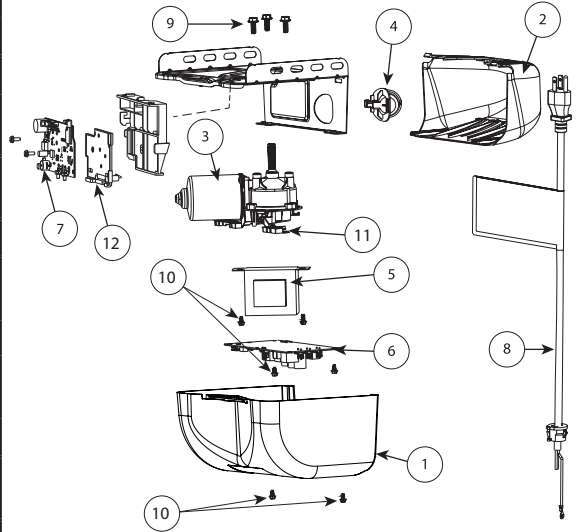

Common Parts - Dual Bulb Powerhead & Integrated LED Models

Item	Description	QTY.
1	Motor assembly (includes encoder and wire)	1
2	Light socket assembly (identify bulb type)	2
3	Genie LED bulb	2
4	Transformer, 120V	1
5	Circuit board assembly, main (identify green or blue color)	1
6	Circuit board assembly, Wi-Fi	1
7	Power cord assembly (identify 4' or 6')	1
8	Screws, motor (3pk; M6-1x12)	1
9	Screws, cover and/or transformer (3pk; #8x5/16)	2
10	Optical encoder replacement assembly	1

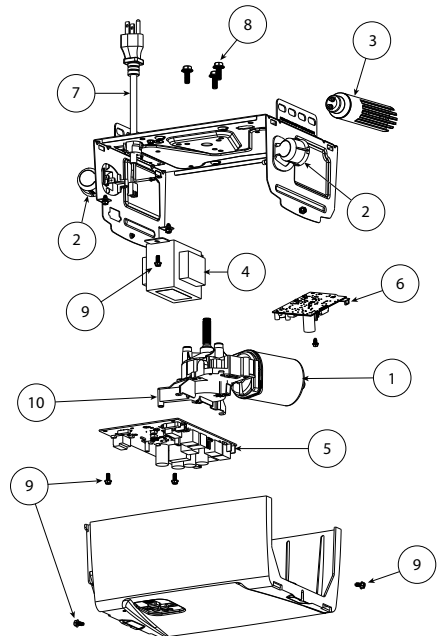

REPLACEMENT POWERHEAD PARTS

Please have your specific opener model number (on opener powerhead) or serial number (front of this manual) when ordering parts.

Model Specific Parts

2-Piece Cover & Lens

1. Lens
2. Secondary Cover
3. Main Cover

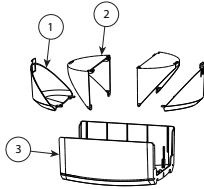

1-Piece Cover & Lens

1. Lens
2. Main Cover

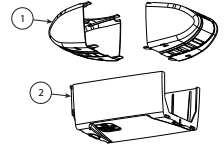

End Panel Design (Horseshoe LED)

1. Lens Kit
2. End panel kit (left & right sides)
3. Complete kit: Full cover, end panels, lens, & LEDs

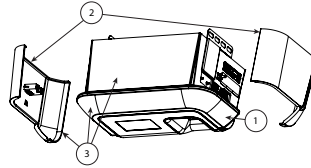

Hidden Panel Design (LED Ends)

1. Lens (1 end)
2. Hidden panel door
3. Complete kit: Full cover, hidden panel door, 2 lenses, & LEDs

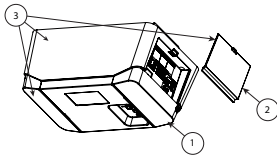

Battery Backup Cases & Battery Only

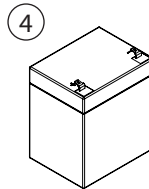
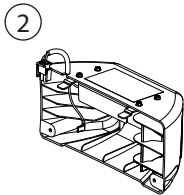
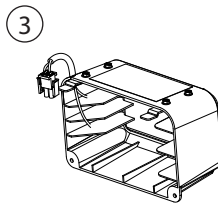
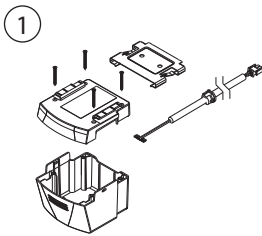

1. Battery case and hardware for single bulb models
2. Battery case and hardware for dual bulb models
3. Battery case and hardware for integrated LED models
4. Battery only, all models

CHANNEL & TUBE RAIL PARTS

Please have your specific opener model number (on opener powerhead) or serial number (front of this manual) when ordering parts.

Channel Parts

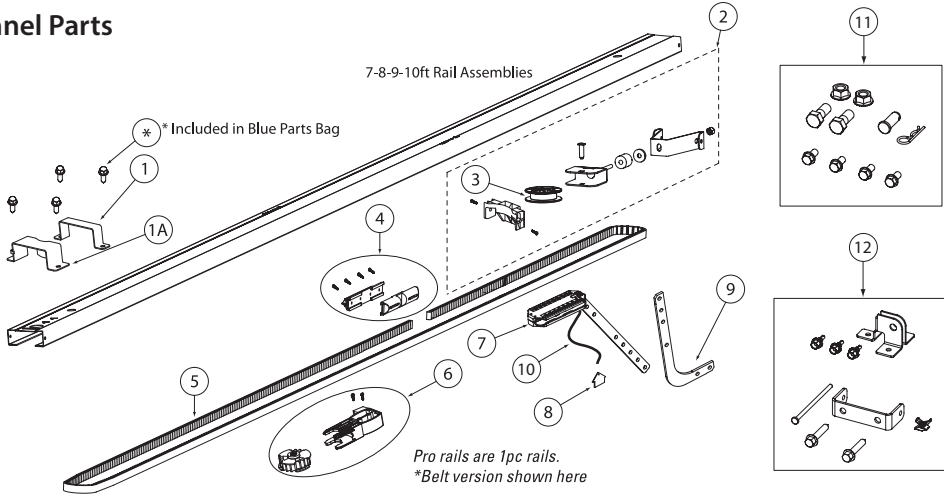

Item	Part Number	Description	QTY.
1	36728A.S	Head To Rail Bracket (Need 2 for Chain, 1 for Belt)	1
1A	36987A.S	Head To Rail Bracket Belt Guard (for Belt only)	1
2	37857R.S	Tensioner Assembly	1
3	36764A.S	Pulley Tensioner	1
4	37557R.S	Chain Bullet Assembly	1
	37556R.S	Belt Bullet Assembly	1
5	37562R.S	Chain & Bullet Assembly, 7 ft	1
	37562S.S	Chain & Bullet Assembly, 8 ft	1
	37562T.S	Chain & Bullet Assembly, 10 ft (292")	1
	39381R.S	Chain & Bullet Assembly, 10 ft (303")	1
	37561R.S	Belt & Bullet Assembly, 7 ft	1
	37561S.S	Belt & Bullet Assembly, 8 ft	1
	37561W.S	Belt & Bullet Assembly, 9 ft (268")	1
	39380U.S	Belt & Bullet Assembly, 9 ft (279")	1
	37561T.S	Belt & Bullet Assembly, 10 ft (292")	1
	39380R.S	Belt & Bullet Assembly, 10 ft (303")	1

Item	Part Number	Description	QTY.
6	37559R.S	Chain Drive Sprocket Assembly	1
	37558R.S	Belt Drive Sprocket Assembly	1
7	36773R.S	Carriage Assembly, 7 ft Doors	1
	36773S.S	Carriage Assembly, 8 ft Doors	1
	36773T.S	Carriage Assembly, 9, 10 ft Doors	1
8	37107C.S	Carriage Release Handle	1
9	26013D.S	Curved Door Arm	1
10	37461R.S	Release Cord Assembly, 7' (32")	1
	37461S.S	Release Cord Assembly, 8' (44")	1
	37461T.S	Release Cord Assembly, 9-14' (116")	1
11	37049R.S	Installation Parts Pack (Blue Bag)	1
12	37047R.S	Mounting Parts Pack (Orange Bag)	1
NS	37714S.S	Wire Clips, (50 pcs)	1
NS	38245R.S	3PC Service Rail, C-Channel Chain Drive Rail	1
NS	38246R.S	3PC Service Rail, C-Channel Belt Drive Rail	1

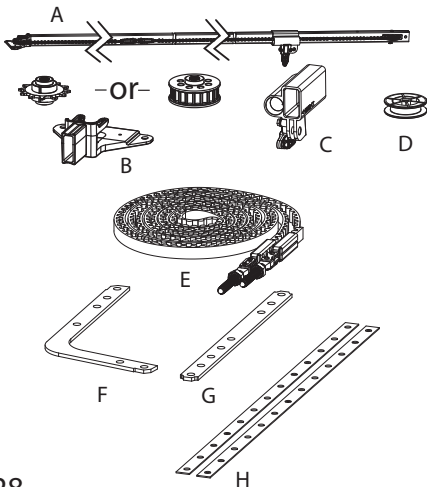

Tube Rail Parts

Item	Part Number	Description	QTY.
A	39410R.S	5-pcs. Rail Assembly Complete (Chain)	1
	39400R.S	5-pcs. Rail Assembly Complete (Belt)	1
B	39277R.S	Sprocket Support Assembly (Chain)	1
	39278R.S	Sprocket Support Assembly (Belt)	1
C	38893R.S	Carriage Assembly	1
D	39276R.S	Idler Pulley	1
E	39352R.S	Chain Assembly (7Ft)	1
	39354R.S	Belt Assembly (7Ft)	1
F	37476A.S	Door Arm, Curved	1
G	37475A.S	Door Arm, Straight	1
H	21243B.S	Strap, Hanging, 3/4 X 25	2

8 DASMA SAFETY GUIDELINES

Automatic Garage Door Opener Safety & Maintenance Guide

Garage Door Opener Safety - An Automatic Decision

! WARNING

A garage door is the largest moving object in the home. An improperly adjusted garage door and opener can exert deadly force when the door closes – which could lead to entrapment of children or adults and subsequent injury or death.

Proper installation, operation, maintenance, and testing of the garage door and automatic opener are necessary to provide a safe, trouble-free system. Careless operation or allowing children to play with or use garage door opener controls are also dangerous situations that can lead to tragic results. A few simple precautions can protect your family and friends from potential harm. Please review the safety and maintenance tips in this guide carefully and keep it for reference. Check the operation of your garage door and opener to ensure they function in a safe and trouble-free manner. Be sure to read all Important Safety Information found in your garage door opener's manual as it provides more details and safety considerations than can be supplied with this guide.

Garage Door Openers are Not Toys

Discuss garage door and opener safety with your children. Explain the danger of being trapped under the door.

Stay away from a moving door.



The wall-mounted push button should be out of reach of children, at least 5 feet from the nearest standing surface and away from all moving parts. Mount and use the button where you can clearly see the closing garage door.



Keep transmitters and remote controls out of reach of children. Do not let children play with or use transmitters or other remote control devices.



Keep the door in sight until it completely closes when using the wall-mounted push button or transmitter.



Routine Maintenance Can Prevent Tragedies

Make monthly inspection and testing of your garage door and opener system a part of your regular routine. Review your owner's manual for both the door and door opener. If you don't have the owner's manuals, contact the manufacturer(s) and request a copy for your specific model(s). Look for the opener model number on the back of the power unit.



WARNING

Springs are under high tension. Do not loosen or adjust any bottom brackets, red colored fasteners, cables, or supports. Only trained door system technicians should adjust these components.

Visually check the door and installation:

- Starting with the door in the closed position, use the manual disconnect on the opener to disconnect the door.
- Look for signs of wear or damage on hinges, rollers, springs, and door panels.
- These parts may require periodic lubrication. Check the owner's manual for suggested maintenance.
- If any signs of damage are evident, contact a trained door systems technician for assistance.
- Verify the photo eye height is no higher than 6" from the garage floor.



Test the door for proper operation:

- Open and close the door manually using handles or suitable gripping points.
- The door should move freely and without difficulty.
- The door should balance and stay partially open 3–4 feet above the floor.
- If you detect any signs of improper operation, contact a trained door systems technician for assistance.

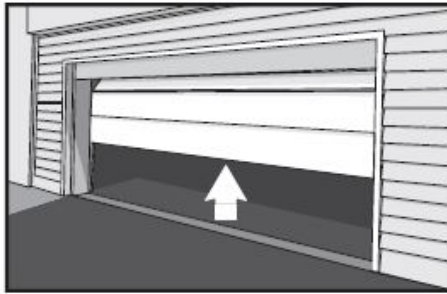

Test the opener safety features:

- Reconnect the opener to the door using the manual disconnect and open the door.
- Place a 2x4 board flat in the path of the door (1) and try to close it (2). The door should stop when it comes in contact with the 2x4 and then reverse direction.
- Block the photoelectric sensor by waving an object in front of the sensor and attempt to close the door. The door should not close unless the wall-mounted push button is manually held during operation.
- If the opener does not perform as described, contact a trained door systems technician for assistance.

